

# COMBOS

## TEMPERATURA



### VÁLVULA TERMOSTÁTICA COMPLETA



2023

3ª EDIÇÃO



[www.mte-thomson.com.br](http://www.mte-thomson.com.br)

### COMBOS

<b>#1</b>	GM-CHEVROLET . . . . .	4
<b>#2</b>	FORD . . . . .	4
<b>#3</b>	FORD . . . . .	5
<b>#4</b>	VOLKSWAGEN . . . . .	5
<b>#5</b>	VOLKSWAGEN . . . . .	6
<b>#6</b>	FIAT . . . . .	6
<b>#7</b>	FIAT . . . . .	7
<b>#8</b>	FIAT . . . . .	7
<b>#9</b>	FIAT . . . . .	8
<b>#10</b>	FIAT . . . . .	8
<b>#11</b>	FIAT . . . . .	9
<b>#12</b>	VOLKSWAGEN . . . . .	9
<b>#13</b>	VOLKSWAGEN . . . . .	10
<b>#14</b>	VOLKSWAGEN . . . . .	10
<b>#15</b>	VOLKSWAGEN . . . . .	11
<b>#16</b>	VOLKSWAGEN . . . . .	11
<b>#17</b>	FIAT . . . . .	12
<b>#18</b>	FORD . . . . .	12
<b>#19</b>	CITROËN - PEUGEOT . . . . .	13
<b>#20</b>	FIAT - GM-CHEVROLET . . . . .	14
<b>#21</b>	FIAT . . . . .	15
<b>#22</b>	FIAT . . . . .	15
<b>#23</b>	FIAT . . . . .	16
<b>#24</b>	FIAT . . . . .	16
<b>#25</b>	FIAT . . . . .	17
<b>#26</b>	FIAT . . . . .	17
<b>#27</b>	FIAT . . . . .	18
<b>#28</b>	FORD . . . . .	18
<b>#29</b>	FORD . . . . .	19
<b>#32</b>	VOLKSWAGEN . . . . .	19
<b>#33</b>	VOLKSWAGEN . . . . .	20
<b>#34</b>	PEUGEOT . . . . .	20



### COMBOS

<b>#35</b>	CITROËN . . . . .	21
<b>#36</b>	VOLKSWAGEN . . . . .	21
<b>#37</b>	VOLKSWAGEN . . . . .	22
<b>#38</b>	GM-CHEVROLET . . . . .	22
<b>#39</b>	GM-CHEVROLET . . . . .	23
<b>#40</b>	FORD . . . . .	23
<b>#41</b>	FIAT . . . . .	24
<b>#42</b>	RENAULT . . . . .	24
<b>#43</b>	PEUGEOT - RENAULT . . . . .	25
<b>#44</b>	FIAT . . . . .	25
<b>#45</b>	VOLKSWAGEN . . . . .	26
<b>#46</b>	VOLKSWAGEN . . . . .	26
<b>#47</b>	FIAT . . . . .	27
<b>#48</b>	CITROËN - PEUGEOT . . . . .	28
<b>#49</b>	FORD . . . . .	29
<b>#50</b>	NISSAN - RENAULT . . . . .	29
<b>#51</b>	CITROËN - PEUGEOT . . . . .	30
<b>#52</b>	HONDA . . . . .	31
<b>#53</b>	RENAULT . . . . .	31
<b>#54</b>	RENAULT . . . . .	32
<b>#55</b>	FIAT - JEEP . . . . .	32
<b>#56</b>	FORD . . . . .	33
<b>#57</b>	GM-CHEVROLET . . . . .	33
<b>#58</b>	GM-CHEVROLET . . . . .	34
<b>#59</b>	GM-CHEVROLET . . . . .	34
<b>#60</b>	FIAT . . . . .	35
<b>#61</b>	FIAT . . . . .	35
<b>#62</b>	CITROËN - PEUGEOT . . . . .	36
<b>#63</b>	FORD . . . . .	36
<b>#64</b>	FIAT . . . . .	37
<b>#65</b>	GM-CHEVROLET . . . . .	37
<b>#66</b>	GM-CHEVROLET . . . . .	38
<b>#67</b>	CITROËN - PEUGEOT . . . . .	39



### COMBO #1

**K-20001** VT313.92+4050

### GM-CHEVROLET

MODELO	MOTOR	COMB.	ANO
AGILE	1.4 8V	FLEX	10/
CELTA	1.0 8V MPFI	GAS./FLEX	01/09
	1.4 8V MPFI	GAS.	01/09
CLASSIC	1.0 8V, 1.6 8V	FLEX	02/06
COBALT	1.4 8V, 1.8 8V	FLEX	12/15
CORSA	1.0 8V, 1.6 8V, 1.8 8V	GAS./FLEX	94/07
MONTANA	1.4 8V	FLEX	07/15
SPIN	1.8 8V	FLEX	13/15



### COMBO #2

**K-20002** VT401.82+4067

### FORD

MODELO	MOTOR	COMB.	ANO
COURIER	1.6 ZETEC ROCAM	GAS.	99/02
ESCORT	1.6 ZETEC ROCAM	GAS.	00/02
FIESTA	1.0, 1.6 ZETEC	GAS.	99/04
KA	1.0, 1.6 ZETEC	GAS.	03/08





### COMBO #3

**K-20003** VT402.82+4067

### FORD

MODELO	MOTOR	COMB.	ANO
COURIER	1.6 ZETEC ROCAM	GAS.	02/08
ECOSPORT	1.0, 1.6 ZETEC	GAS.	03/06
FIESTA	1.0, 1.6 ZETEC	GAS.	02/08
FOCUS	1.6 ZETEC ROCAM	GAS.	03/09

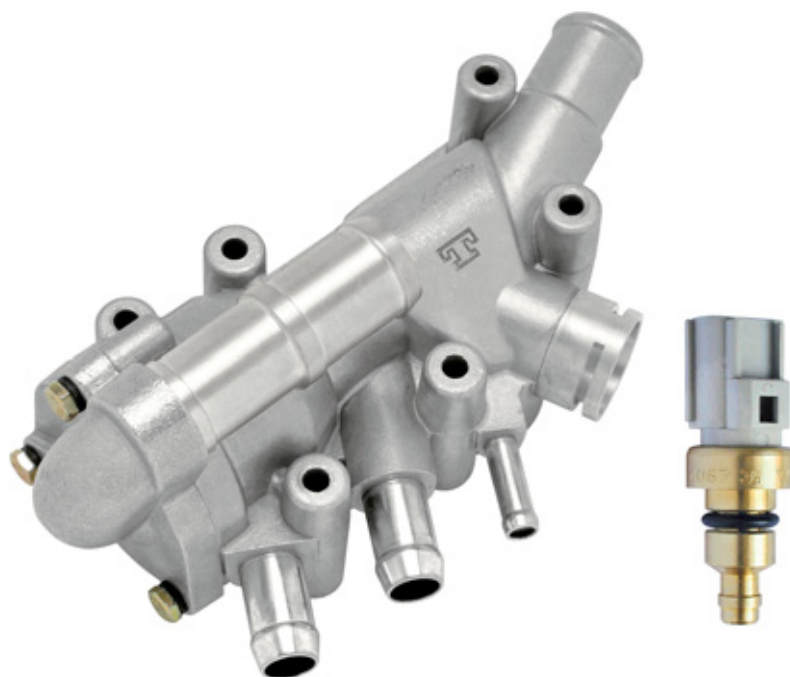

### COMBO #4

**K-20004** VT562.87+4034

### VOLKSWAGEN

MODELO	MOTOR	COMB.	ANO	OBSERVAÇÃO
GOL	1.0 AT 16V TURBO	GAS.	00/02	COM AR
	1.0 MI AT 16V	GAS.	97/01	COM AR
	1.0 MI AT 8V	GAS./ETANOL	96/02	COM AR
PARATI	1.0 MI AT 16V	GAS.	97/02	COM AR
	1.0 MI AT 16V TURBO	GAS.	00/02	COM AR



**87°C SEM TUBO**



### COMBO #5

**K-20005** VT563.87+4034

### VOLKSWAGEN

MODELO	MOTOR	COMB.	ANO	OBS.
GOL	1.0 AT 16V TURBO	GAS.	00/02	SEM AR
	1.0 MI AT 16V	GAS.	97/01	SEM AR
	1.0 MI AT 8V	GAS./ETANOL	96/02	SEM AR
PARATI	1.0 MI AT 16V EFI	GAS.	97/02	SEM AR

87°C SEM TUBO



### COMBO #6

**K-20006** VT251.87+4053+3071

### FIAT

MODELO	MOTOR	COMB.	ANO	OBS.
PALIO EL	1.5 MPI 8V	GAS.	96/97	COM AR
PALIO ED	1.0 MPI 8V	GAS.	96/97	COM AR
PALIO EDX	1.0 MPI 8V	GAS.	96/97	COM AR

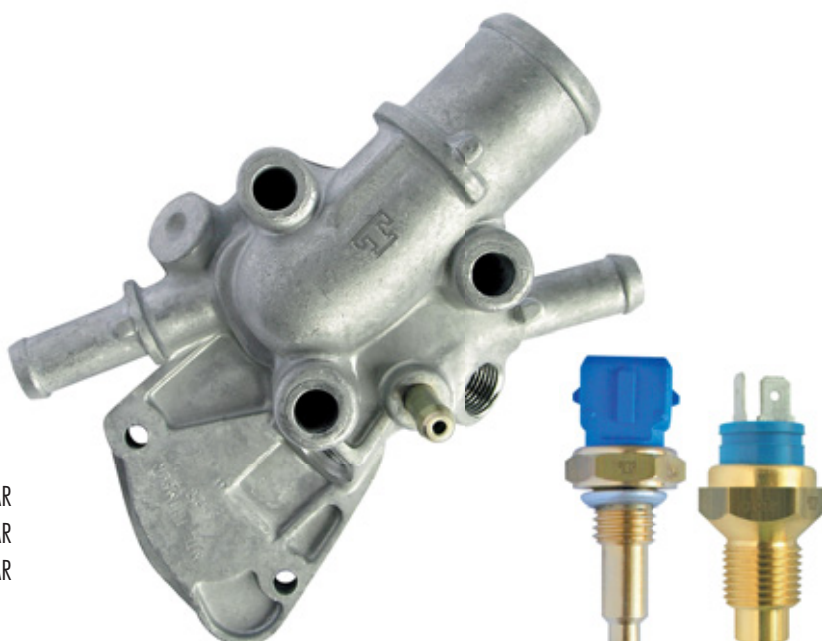





### COMBO #7

**K-20007** VT251.87+4053+3046

#### FIAT

MODELO	MOTOR	COMB.	ANO	OBS.
PALIO ED	1.0 MPI 8V	GAS.	97/98	COM AR
STRADA WORKING	1.5 MPI 8V	GAS.	99/00	COM AR

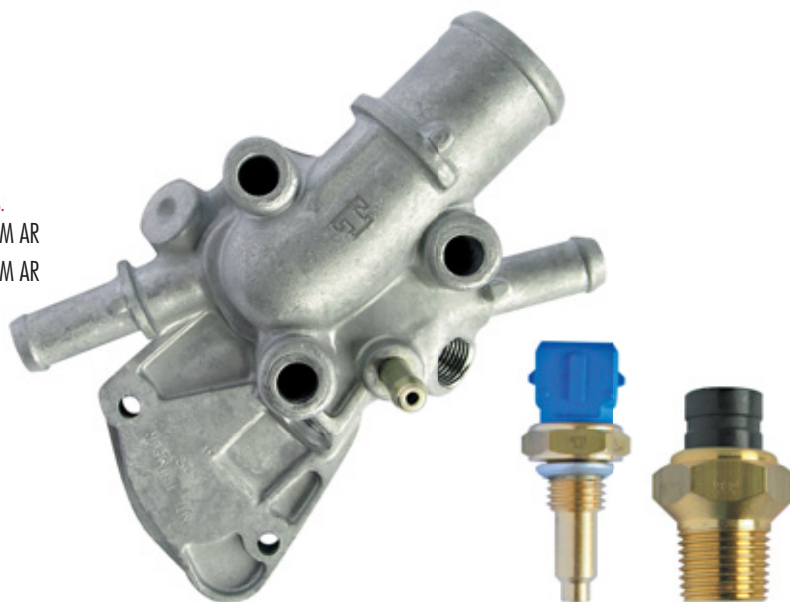

### COMBO #8

**K-20008** VT251.87+4053+3041

#### FIAT

MODELO	MOTOR	COMB.	ANO	OBS.
PALIO EX	1.0 MPI 8V	GAS.	98/98	COM AR
PALIO WEEKEND	1.5 MPI 8V	GAS./ETANOL	97/99	COM AR
SIENA 6 MARCHAS	1.0 MPI 8V	GAS.	99/00	COM AR
SIENA EL-ELX	1.5 MPI 8V	ETANOL	99/00	COM AR

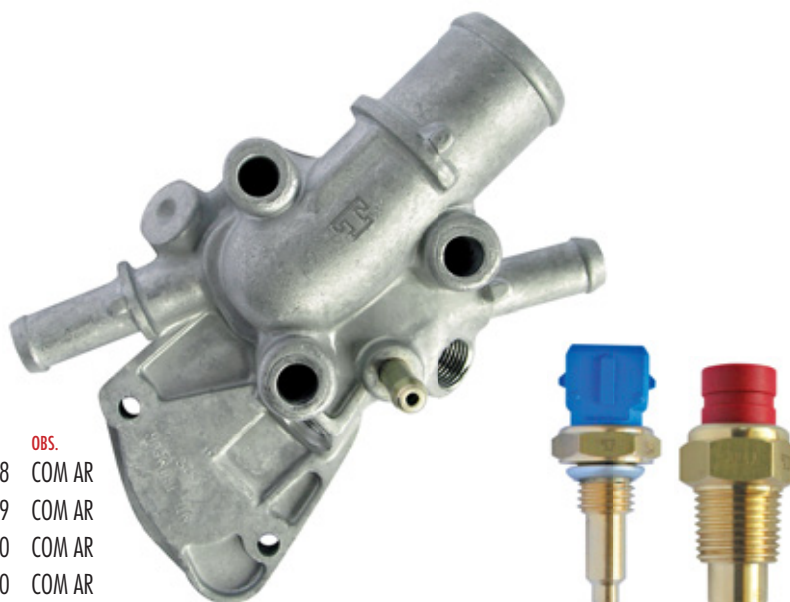



### COMBO #9

**K-20009** VT250.87+4053+3071

#### FIAT

MODELO	MOTOR	COMB.	ANO	OBS.
PALIO EL	1.5 MPI 8V	GAS.	96/97	SEM AR
PALIO ED	1.0 MPI 8V	GAS.	96/97	SEM AR
PALIO EDX	1.0 MPI 8V	GAS.	96/97	SEM AR



### COMBO #10

**K-20010** VT250.87+4053+3046

#### FIAT

MODELO	MOTOR	COMB.	ANO	OBS.
PALIO ED	1.0 MPI 8V	GAS.	97/98	SEM AR
STRADA WORKING	1.5 MPI 8V	GAS.	99/00	SEM AR







### COMBO #11

#### K-20011 VT250.87+4053+3041

### FIAT

MODELO	MOTOR	COMB.	ANO	OBS.
PALIO EX	1.0 MPI 8V	GAS.	98/98	SEM AR
PALIO WEEKEND	1.5 MPI 8V	GAS./ETANOL	97/99	SEM AR
SIENA 6 MARCHAS	1.0 MPI 8V	GAS.	99/00	SEM AR
SIENA EL-ELX	1.5 MPI 8V	ETANOL	99/00	SEM AR

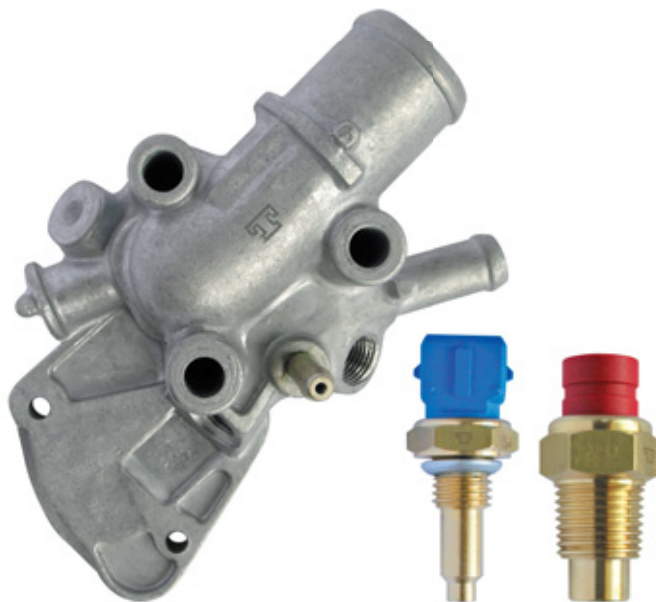

### COMBO #12

#### K-20012 VT601.80+4014

### VOLKSWAGEN

MODELO	MOTOR	COMB.	ANO
CROSSFOX	1.6 8V	FLEX	05/10
FOX	1.0, 1.6 8V EA111	FLEX	04/10
SPACEFOX	1.6 8V	FLEX	06/10



80°C SEM TUBO



### COMBO #13

**K-20013** VT601.80+4092

### VOLKSWAGEN

MODELO	MOTOR	COMB.	ANO
FOX	1.0, 1.6 8V EA111	FLEX	10/
GOL	1.0, 1.6 8V EA111	FLEX	08/
GOLF	1.6 8V EA111	FLEX	08/14
POLO	1.0, 1.6 8V EA111	FLEX	02/14
SAVEIRO	1.6 8V EA111	FLEX	09/
SPACE FOX	1.6 8V	FLEX	10/
VOYAGE	1.0, 1.6 8V EA111	FLEX	08/

80°C SEM TUBO



### COMBO #14

**K-20014** VT245.80 CT+4034

### VOLKSWAGEN

MODELO	MOTOR	COMB.	ANO	OBS.
GOL	1.0 AT 16V TURBO	000	00/02	SEM E COM AR
	1.0 MI AT 16V	000	97/01	SEM E COM AR
	1.0 MI AT 8V	000	96/02	SEM E COM AR
PARATI	1.0 MI AT 16V	000	97/02	SEM E COM AR
	1.0 MI AT 16V TURBO	000	00/02	SEM E COM AR

80°C COM TAMPA





### COMBO #15

**K-20015** VT245.80 CT+4014

### VOLKSWAGEN

MODELO	MOTOR	COMB.	ANO
CROSSFOX	1.6 8V	FLEX	05/10
FOX	1.0, 1.6 8V EA111	FLEX	04/10
SPACEFOX	1.6 8V	FLEX	06/10

80°C COM TAMPA



### COMBO #16

**K-20016** VT245.80 CT+4092

### VOLKSWAGEN

MODELO	MOTOR	COMB.	ANO
CROSSFOX	1.6 8V	FLEX	10/
FOX	1.0, 1.6 8V EA111	FLEX	10/
GOL	1.0, 1.6 8V EA111	FLEX	08/
GOLF	1.6 8V EA111	FLEX	08/14
POLO	1.0, 1.6 8V EA111	FLEX	02/14
SAVEIRO	1.6 8V EA111	FLEX	09/
SPACE FOX	1.6 8V	FLEX	10/
VOYAGE	1.0, 1.6 8V EA111	FLEX	08/

80°C COM TAMPA





### COMBO #17

#### K-20017 VT422.88+4147

#### FIAT

MODELO	MOTOR	COMB.	ANO
FIORINO	1.4 8V FIRE EVO	FLEX	14/
MOBI	1.0 8V FIRE EVO	FLEX	16/
PALIO	1.0, 1.4 8V FIRE EVO	FLEX	12/
UNO	1.0, 1.4 8V FIRE EVO	FLEX	14/

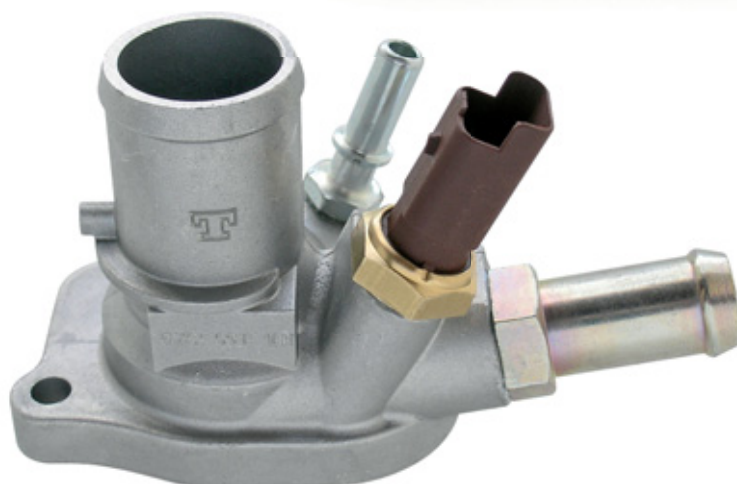

### COMBO #18

#### K-20018 VT421.100+4067

#### FORD

MODELO	MOTOR	COMB.	ANO
ECOSPORT	1.6 8V ZETEC ROCAM	FLEX	05/12
FIESTA	1.0, 1.6 8V ZETEC ROCAM	FLEX	04/14
FOCUS	1.6 8V ZETEC ROCAM	FLEX	08/09

#### VÁLVULA ELETRÔNICA

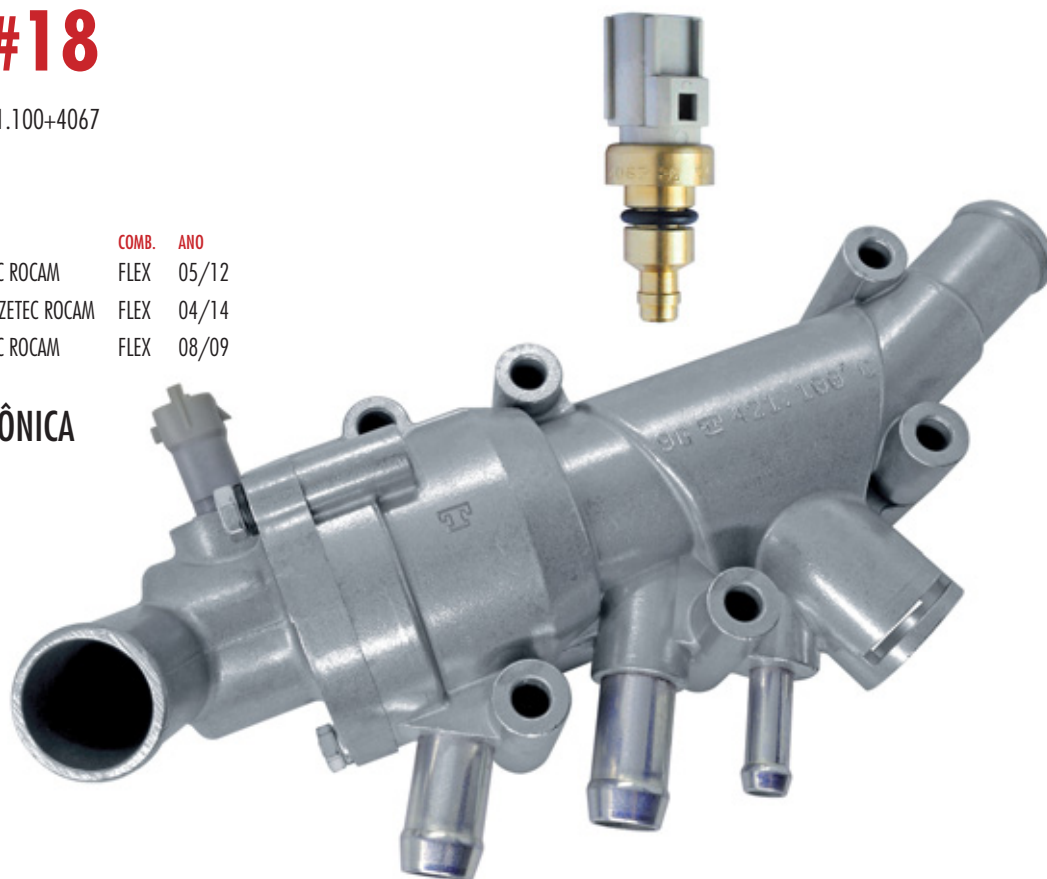



### COMBO #19

**K-20019** VT487.91+4111

### CITROËN

MODELO	MOTOR	COMB.	ANO
AIRCROSS	1.6 16V	FLEX	11/
C3	1.6 16V	GAS./FLEX	02/
C3 PICASSO	1.6 16V	FLEX	02/
C4	1.6 16V	FLEX	12/14

### PEUGEOT

MODELO	MOTOR	COMB.	ANO
206	1.6 16V	GAS./FLEX	01/10
207	1.6 16V	FLEX	08/13
208	1.6 16V	FLEX	13/
307	1.6 16V	FLEX	02/12
308	1.6 16V	FLEX	12/
HOGGAR	1.6 16V	FLEX	10/12
PARTNER	1.6 16V	FLEX	03/

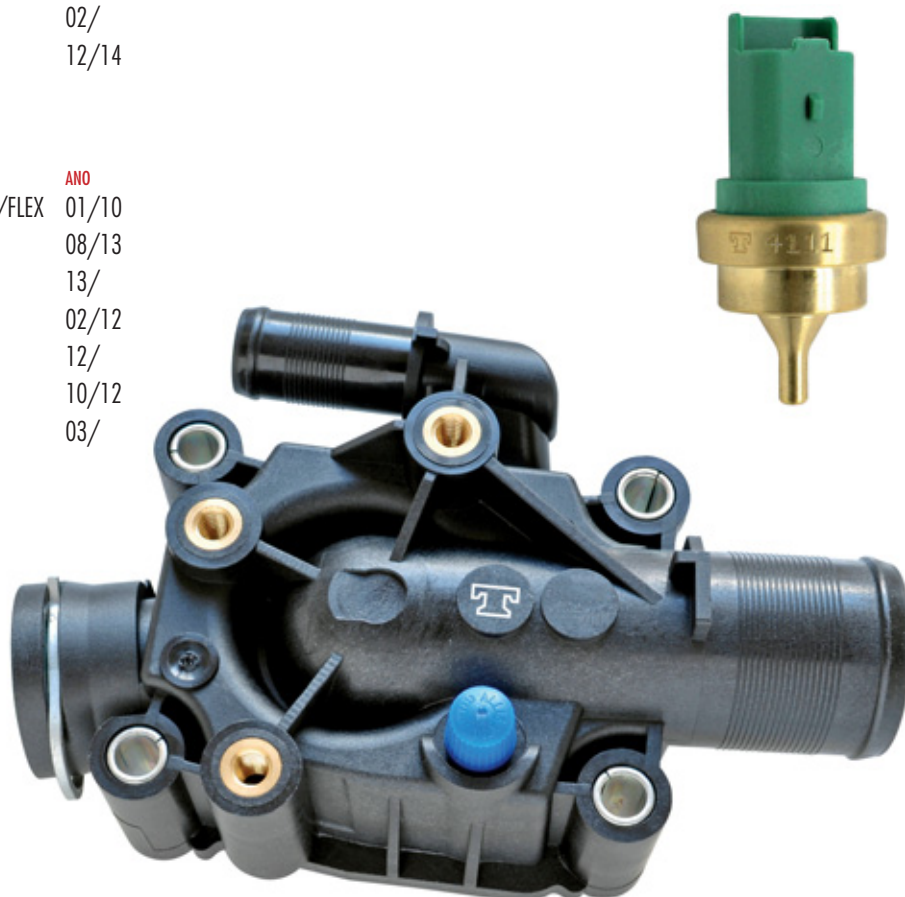



### COMBO #20

#### K-20020 VT313.92+4008

#### FIAT

MODELO	MOTOR	COMB.	ANO
DOBLÓ	1.8 8V	FLEX	06/10
IDEA	1.8 8V	FLEX	06/10
PALIO	1.8 8V	FLEX	06/10
PUNTO	1.8 8V	FLEX	08/10
SIENA	1.8 8V	FLEX	07/10
STILO	1.8 8V	FLEX	04/10
STRADA	1.8 8V	FLEX	07/10

#### GM - CHEVROLET

MODELO	MOTOR	COMB.	ANO
CORSA	1.8 8V	FLEX	03/09
MERIVA	1.8 8V	FLEX	09/12
MONTANA	1.8 8V	FLEX	03/10

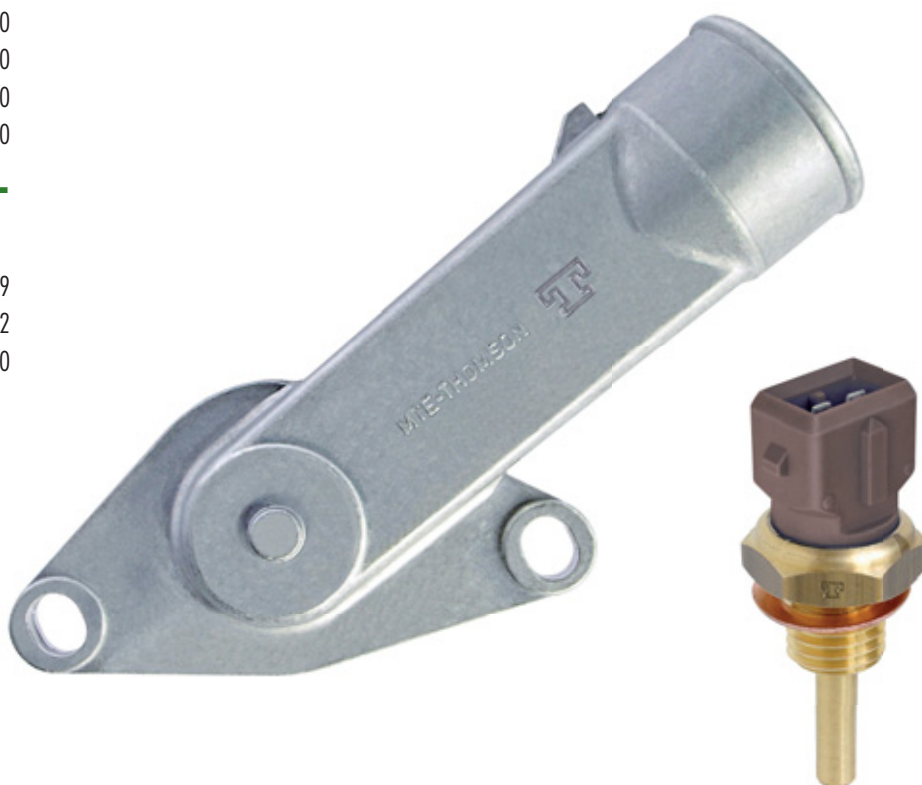





### COMBO #21

**K-20021** VT313.92+4056

#### FIAT

MODELO	MOTOR	COMB.	ANO
DOBLO	1.8 8V	GAS./FLEX	04/06
PALIO	1.8 8V	GAS./FLEX	03/06
SIENA	1.8 8V	GAS./FLEX	03/06
STRADA	1.8 8V	GAS./FLEX	03/06

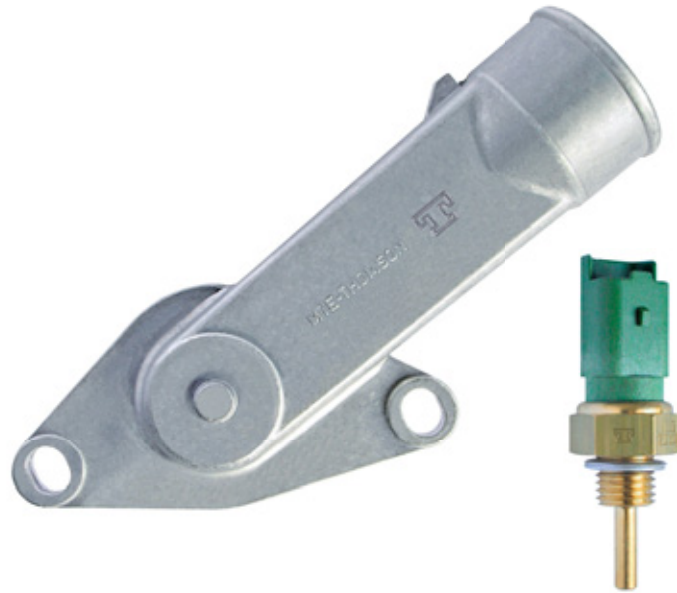

### COMBO #22

**K-20022** VT269.87+4053+3046

#### FIAT

MODELO	MOTOR	COMB.	ANO	OBS.
FIORINO	1.3, 1.5 8V	GAS.	97/04	SEM AR
UNO	1.3 8V	GAS.	01/03	SEM AR
UNO MILLE	1.0 8V	GAS.	99/04	SEM AR

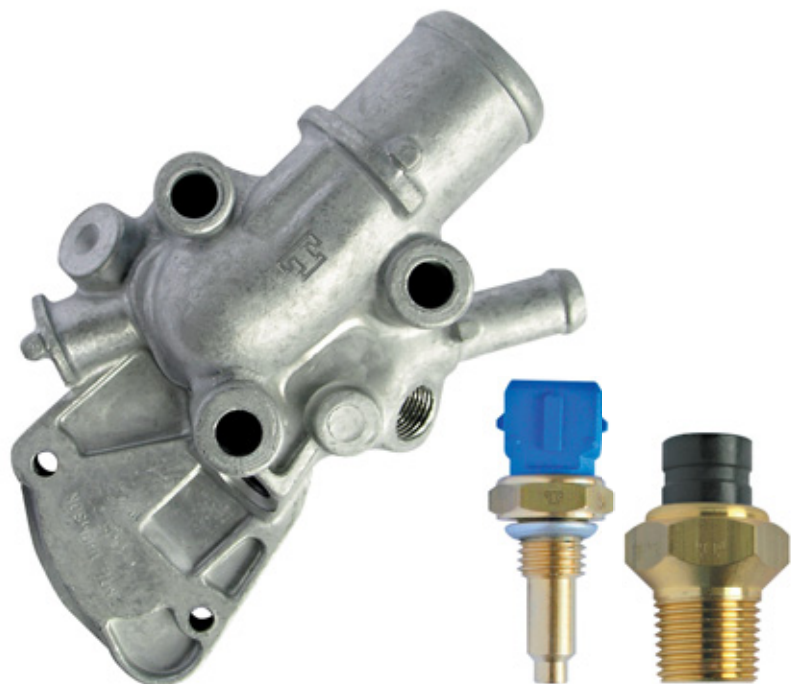



### COMBO #23

**K-20023** VT270.87+4053+3046

#### FIAT

MODELO	MOTOR	COMB.	ANO	OBS.
FIORINO	1.3, 1.5 8V	GAS.	97/04	COM AR
UNO	1.3 8V	GAS.	01/03	COM AR
UNO MILLE	1.0 8V	GAS.	99/04	COM AR



### COMBO #24

**K-20024** VT506.87+4033

#### FIAT

MODELO	MOTOR	COMB.	ANO	OBS.
FIORINO	1.5 8V	GAS.	04/04	SEM AR
PALIO	1.0, 1.5 8V	GAS.	99/04	SEM AR
SIENA	1.0, 1.5 8V	GAS.	99/04	SEM AR
STRADA	1.5 8V	GAS.	99/04	SEM AR



### COMBO #25

**K-20025** VT516.87+4033

#### FIAT

MODELO	MOTOR	COMB.	ANO	OBS.
FIORINO	1.5 8V	GAS.	04/04	COM AR
PALIO	1.0, 1.5 8V	GAS.	99/04	COM AR
SIENA	1.0, 1.5 8V	GAS.	99/04	COM AR
STRADA	1.5 8V	GAS.	99/04	COM AR



### COMBO #26

**K-20026** VT349.87+4099

#### FIAT

MODELO	MOTOR	COMB.	ANO	OBS.
DOBLÓ	1.4 8V FIRE	FLEX	10/	-
FIORINO	1.3 8V FIRE	GAS./FLEX	03/13	-
IDEA	1.4 8V FIRE	FLEX	06/	-
MILLE	1.0 8V FIRE	GAS./FLEX	02/13	-
PALIO	1.0, 1.3, 1.4 8V FIRE	GAS./FLEX	02/12	-
PUNTO	1.4 8V FIRE	FLEX	08/	-
SIENA	1.0, 1.3, 1.4 8V FIRE	FLEX	02/12	TRETA FUEL
STRADA	1.3, 1.4 8V FIRE	GAS./FLEX	03/	-
UNO	1.0, 1.3 8V FIRE	GAS./FLEX	03/	-

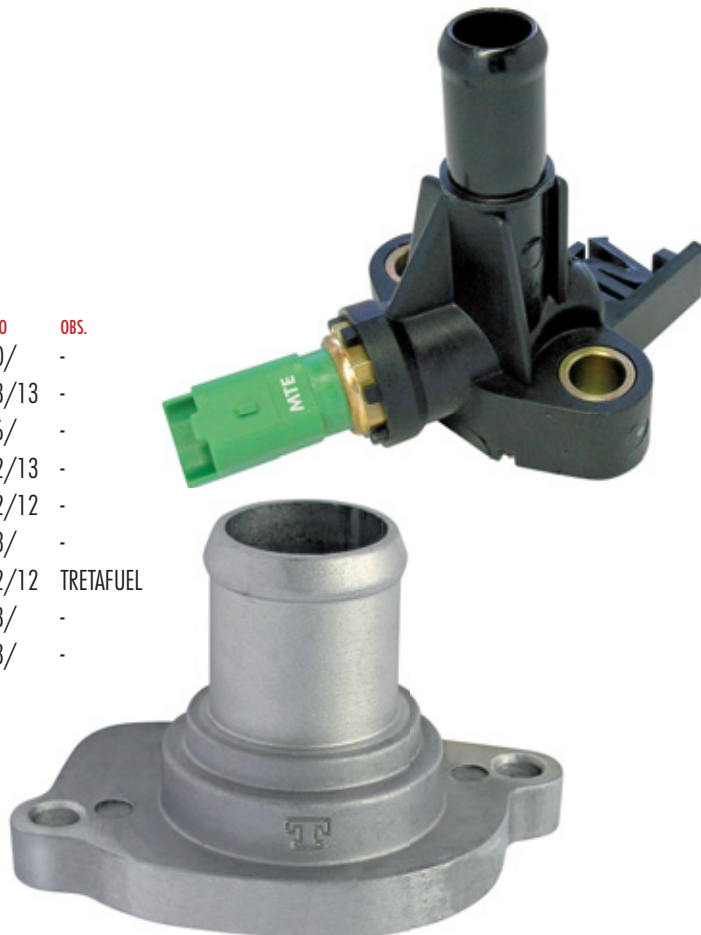



### COMBO #27

**K-20027** VT349.87+4153

#### FIAT

MODELO	MOTOR	COMB.	ANO
DOBLÓ	1.3 16V FIRE	GAS.	02/06
PALIO	1.0, 1.3 16V FIRE	GAS.	00/03
SIENA	1.0, 1.3 16V FIRE	GAS.	00/03



### COMBO #28

**K-20028** VT404.88+4057

#### FORD

MODELO	MOTOR	COMB.	ANO
MONDEO	2.0 ZETEC	GAS.	98/99





### COMBO #29

**K-20029** VT404.88+4037

### FORD

MODELO	MOTOR	COMB.	ANO
ESCORT	1.8 16V ZETEC	GAS.	96/02
MONDEO	1.8 16V ZETEC	GAS.	98/



### COMBO #32

**K-20032** VT445.80+4014

### VOLKSWAGEN

MODELO	MOTOR	COMB.	ANO
CROSSFOX	1.6 8V	FLEX	05/10
FOX	1.0, 1.6 8V EA111	FLEX	04/10
SPACEFOX	1.6 8V	FLEX	06/10



80°C

### COMBO #33

**K-20033** VT445.80+4092

### VOLKSWAGEN

MODELO	MOTOR	COMB.	ANO
CROSSFOX	1.6 8V	FLEX	10/
FOX	1.0, 1.6 8V EA111	FLEX	10/
GOL	1.0, 1.6 8V EA111	FLEX	08/
GOLF	1.6 8V EA111	FLEX	08/14
POLO	1.0, 1.6 8V EA111	FLEX	02/14
SAVEIRO	1.6 8V EA111	FLEX	09/
SPACE FOX	1.6 8V	FLEX	10/
VOYAGE	1.0, 1.6 8V EA111	FLEX	08/

80°C



### COMBO #34

**K-20034** VT370.89+4110

### PEUGEOT

MODELO	MOTOR	COMB.	ANO
206	1.4 8V	GAS./FLEX	05/13
207	1.4 8V	GAS./FLEX	05/13
HOGGAR	1.4 8V	GAS./FLEX	10/13

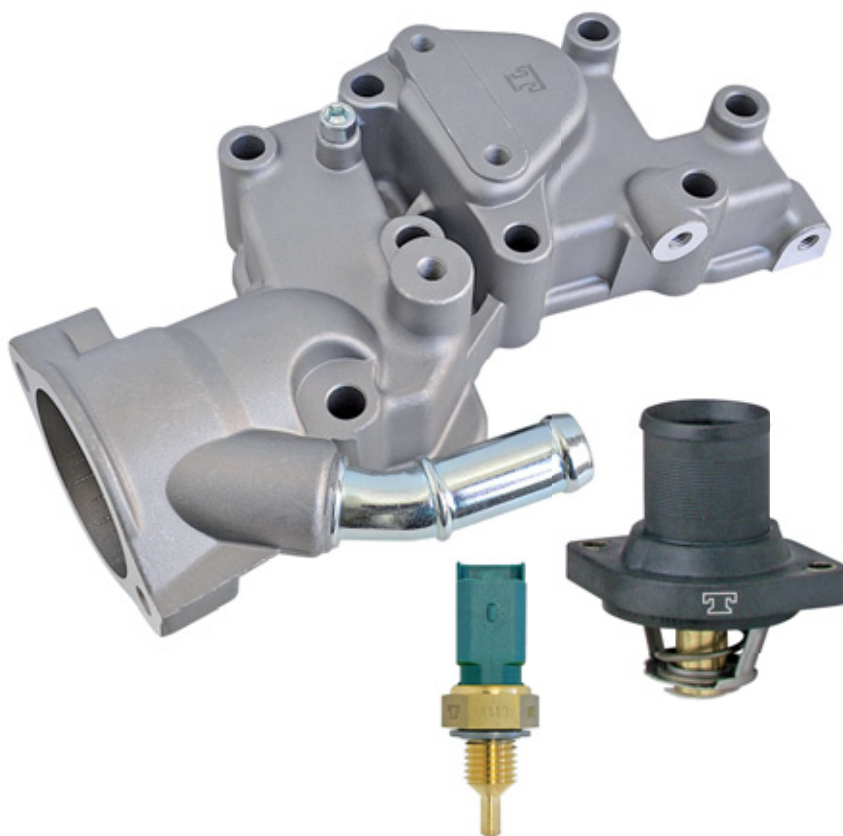



### COMBO #35

**K-20035** VT486.89+4110

### CITROËN

MODELO	MOTOR	COMB.	ANO
C3	1.4 8V	GAS./FLEX	04/13
C3 PLURIEL	1.4 8V	GAS./FLEX	04/13

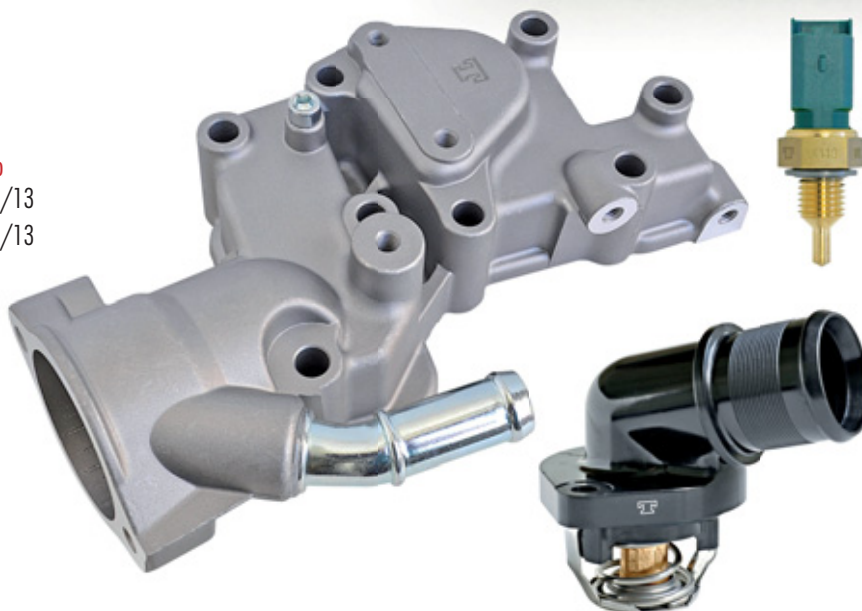

### COMBO #36

**K-20036** VT601.80+4014+TUBO

### VOLKSWAGEN

MODELO	MOTOR	COMB.	ANO
CROSSFOX	1.6 8V	FLEX	05/10
FOX	1.0, 1.6 8V EA111	FLEX	04/10
SPACEFOX	1.6 8V	FLEX	06/10

80°C COM TUBO

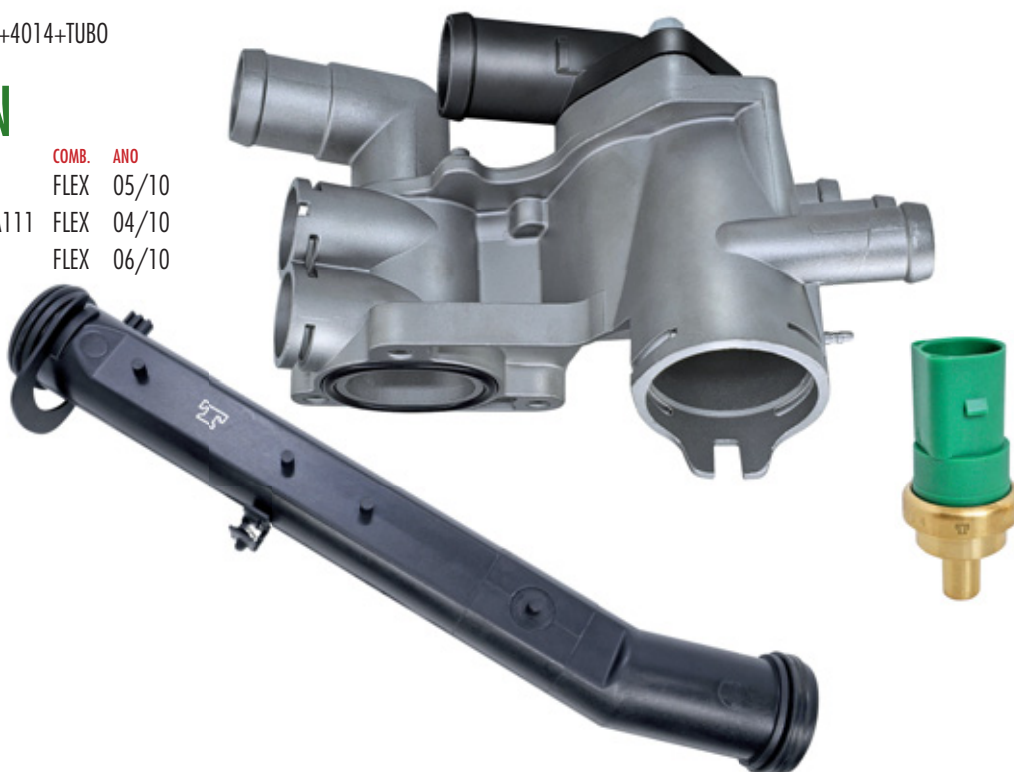

### COMBO #37

**K-20037** VT601.80+4092+TUBO

### VOLKSWAGEN

MODELO	MOTOR	COMB.	ANO
CROSSFOX	1.6 8V	FLEX	10/
FOX	1.0, 1.6 8V EA111	FLEX	10/
GOL	1.0, 1.6 8V EA111	FLEX	08/
GOLF	1.6 8V EA111	FLEX	08/14
POLO	1.0, 1.6 8V EA111	FLEX	02/14
SAVEIRO	1.6 8V EA111	FLEX	09/
SPACE FOX	1.6 8V	FLEX	10/
VOYAGE	1.0, 1.6 8V EA111	FLEX	08/

**80°C COM TUBO**



### COMBO #38

**K-20038** VT313.92+4051

### GM-CHEVROLET

MODELO	MOTOR	COMB.	ANO
CELTA	1.0 8V, 1.4 8V	FLEX	09/15
CLASSIC	1.0 8V	FLEX	09/15
CORSA	1.0 8V, 1.4 8V	FLEX	05/12
MERIVA	1.4 8V	FLEX	09/12
PRISMA	1.0 8V, 1.4 8V	FLEX	10/12

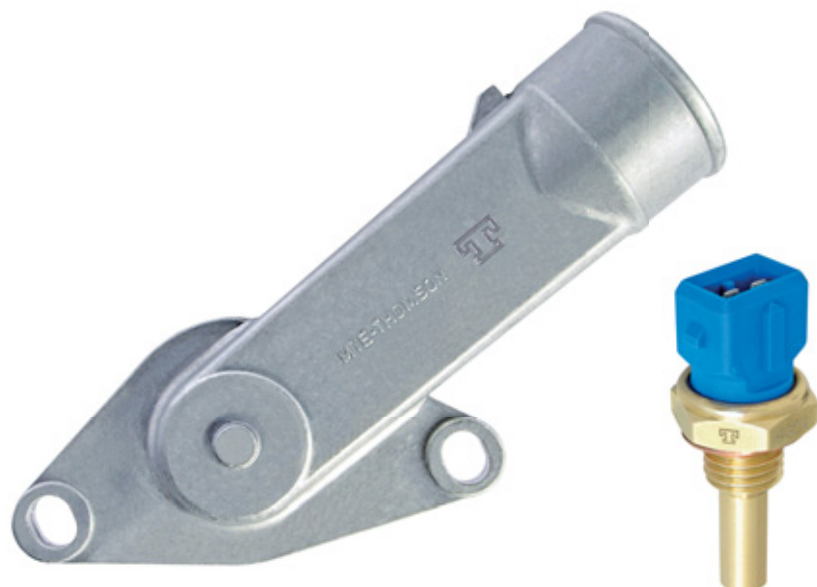



### COMBO #39

**K-20039** VT313.92+4221

### GM - CHEVROLET

MODELO	MOTOR	COMB.	ANO
CLASSIC	1.0 8V	FLEX	16/
COBALT	1.4 8V	FLEX	16/
MONTANA	1.4 8V	FLEX	16/
ONIX	1.0 8V, 1.4 8V	FLEX	13/
PRISMA	1.0 8V, 1.4 8V	FLEX	13/
SPIN	1.8 8V	FLEX	16/



### COMBO #40

**K-20040** VT627.100+4067

### FORD

MODELO	MOTOR	COMB.	ANO
COURIER	1.6 8V ZETEC ROCAM	FLEX	08/13
KA	1.0 8V ZETEC ROCAM	FLEX	08/14







### COMBO #41

**K-20041** VT460.90+4189

#### FIAT

MODELO	MOTOR	COMB.	ANO
BRAVO	1.8 16V E-TORQ	FLEX	11/16
DOBLÓ	1.8 16V E-TORQ	FLEX	11/16
GRAND SIENA	1.6 16V E-TORQ	FLEX	11/16
IDEA	1.8 16V E-TORQ	FLEX	11/16
LINEA	1.8 16V E-TORQ	FLEX	11/16
PALIO	1.6 16V E-TORQ	FLEX	11/16
PUNTO	1.6 16V E-TORQ	FLEX	11/16
SIENA	1.6 16V E-TORQ	FLEX	10/12
STRADA	1.6 16V E-TORQ	FLEX	10/16



### COMBO #42

**K-20042** VT438.89+4058

#### RENAULT

MODELO	MOTOR	COMB.	ANO
CLIO	1.6 16V	GAS.	99/05
DUSTER	1.6 16V	FLEX	12/
KANGGO	1.6 16V	GAS./FLEX	00/11
LOGAN	1.6 16V	FLEX	08/10
MEGANE	1.6 16V	FLEX	07/11
SCENIC	1.6 16V	GAS./FLEX	99/11
SYMBOL	1.6 16V	FLEX	09/13





### COMBO #43

**K-20043** VT371.89+4058

#### PEUGEOT

MODELO	MOTOR	COMB.	ANO
206	1.0 16V	GAS.	99/06

#### RENAULT

MODELO	MOTOR	COMB.	ANO
CLIO	1.0 8V/16V	GAS.	99/
KANGOO	1.0 8V/16V	FLEX	00/05
LOGAN	1.0 16V	FLEX	07/07
SANDERO	1.0 16V	GAS.	08/08
TWINGO	1.0 8V/16V	GAS.	95/13



### COMBO #44

**K-20044** VT321.88+4063+3041

#### FIAT

MODELO	MOTOR	COMB.	ANO	OBS.
BRAVA	1.6 16V	GAS.	96/00	COM AR
PALIO	1.6 16V	GAS.	98/00	COM AR
SIENA	1.6 16V	GAS.	98/98	COM AR
STRADA	1.6 16V	GAS.	98/99	COM AR

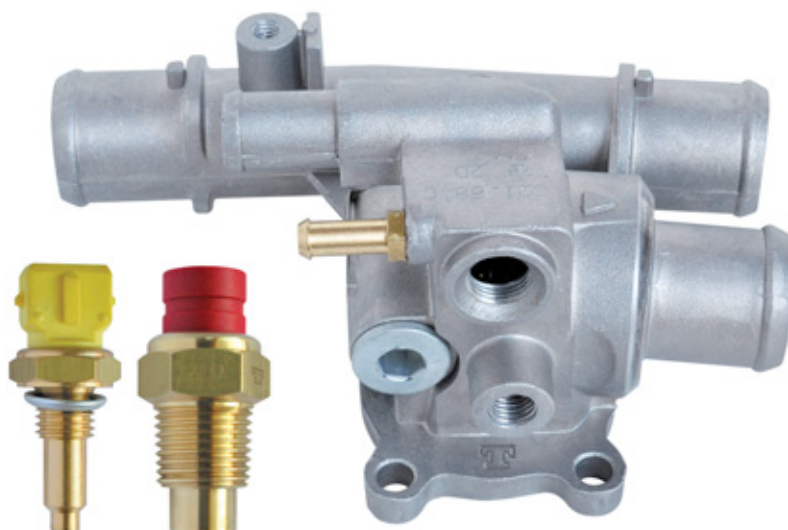



### COMBO #45

**K-20045** VT475.95+4259+VT476.80

### VOLKSWAGEN

MODELO	MOTOR	COMB.	ANO
FOX	1.0 12V 3cil.	FLEX	15/
	1.6 16V	FLEX	15/
GOL	1.0 12V 3cil.	FLEX	16/
	1.6 16V	FLEX	15/
SAVEIRO	1.6 16V	FLEX	15/
UP!	1.0 12V 3cil.	FLEX	14/



### COMBO #46

**K-20046** VT453.80+4179

### VOLKSWAGEN

MODELO	MOTOR	COMB.	ANO
KOMBI	1.4 8V	FLEX	06/13







### COMBO #47

#### K-20047 VT528.90+4217

### FIAT

MODELO	MOTOR	COMB.	ANO
BRAVO	1.8 16V E-TORQ	FLEX	14/17
DOBLÒ	1.8 16V E-TORQ	FLEX	14/17
GRAND SIENA	1.6 16V E-TORQ	FLEX	14/17
IDEA	1.6 16V E-TORQ	FLEX	14/17
	1.8 16V E-TORQ	FLEX	14/17
LINEA	1.8 16V E-TORQ	FLEX	14/17
NOVO PALIO	1.6 16V E-TORQ	FLEX	14/17
PUNTO	1.6 16V E-TORQ	FLEX	14/17
STRADA	1.6 16V E-TORQ	FLEX	14/17
	1.8 16V E-TORQ	FLEX	14/17



### COMBO #48

**K-20048** VT504.89+4083

### CITROËN

MODELO	MOTOR	COMB.	ANO
C4 PALLAS	2.0 16V EW10J4	GAS.	08/
C4 PICASSO	2.0 16V EW10J4	GAS.	08/
C4 GRAND PICASSO	2.0 16V EW10J4	GAS.	08/
C4 VTR	2.0 16V EW10A	GAS.	07/
C5	2.0 16V EW10A	GAS.	07/

### PEUGEOT

MODELO	MOTOR	COMB.	ANO
307	2.0 16V EW10A	GAS.	07/
308	2.0 16V EW10A	GAS.	07/
406	2.0 16V EW10J4	GAS.	07/
407	2.0 16V EW10J4	GAS.	07/
408	2.0 16V EW10A	GAS.	07/
807	2.0 16V EW10J4	GAS.	07/

**NOTA:** CÂMBIO MANUAL 89°C

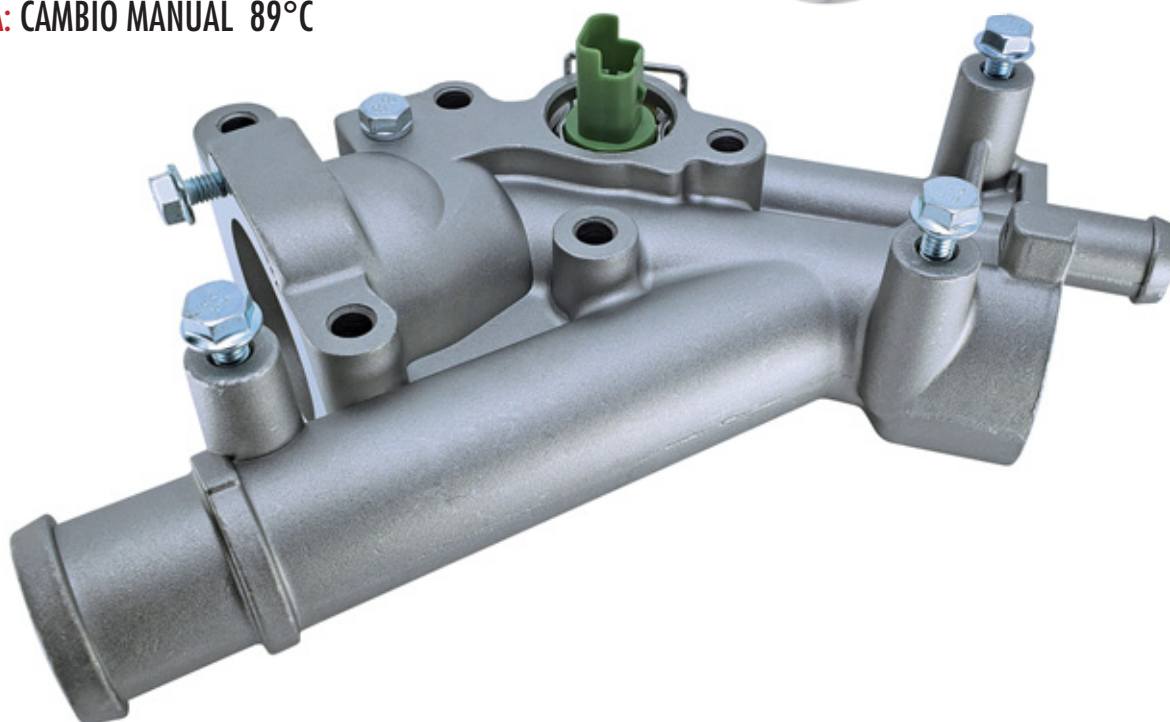

### COMBO #49

**K-20049** VT467.92 + VT547.50+4107

#### FORD

MODELO	MOTOR	COMB.	ANO
KA	1.0 12V SIGMA	FLEX	14/
KA+	1.0 12V SIGMA	FLEX	14/



### COMBO #50

**K-20050** VT441.82+VT317.95+4000

#### NISSAN

MODELO	MOTOR	COMB.	ANO
SENTRA	2.0 16V	GAS.	07/08
LIVINA	1.8 16V	FLEX.	11/15
TIIDA	1.8 16V	GAS./FEX	09/13
X-TRAIL	2.5 16V	GAS.	05/08

#### RENAULT

MODELO	MOTOR	COMB.	ANO
FLUENCE	2.0 16V	FLEX	11/16





### COMBO #51

**K-20051** VT504.80+4083

### CITROËN

MODELO	MOTOR	COMB.	ANO
C4	2.0 16V	FLEX	09/
C4 LAUNGE	2.0 16V	FLEX	13/
C4 PALLAS	2.0 16V	FLEX	08/13
C5	2.0 16V	FLEX	08/10

### PEUGEOT

MODELO	MOTOR	COMB.	ANO
307	2.0 16V	FLEX	08/
308	2.0 16V	FLEX	12/
407	2.0 16V	FLEX	05/11
408	2.0 16V	FLEX	11/

**NOTA:** CÂMBIO AUTOMÁTICO 80°C

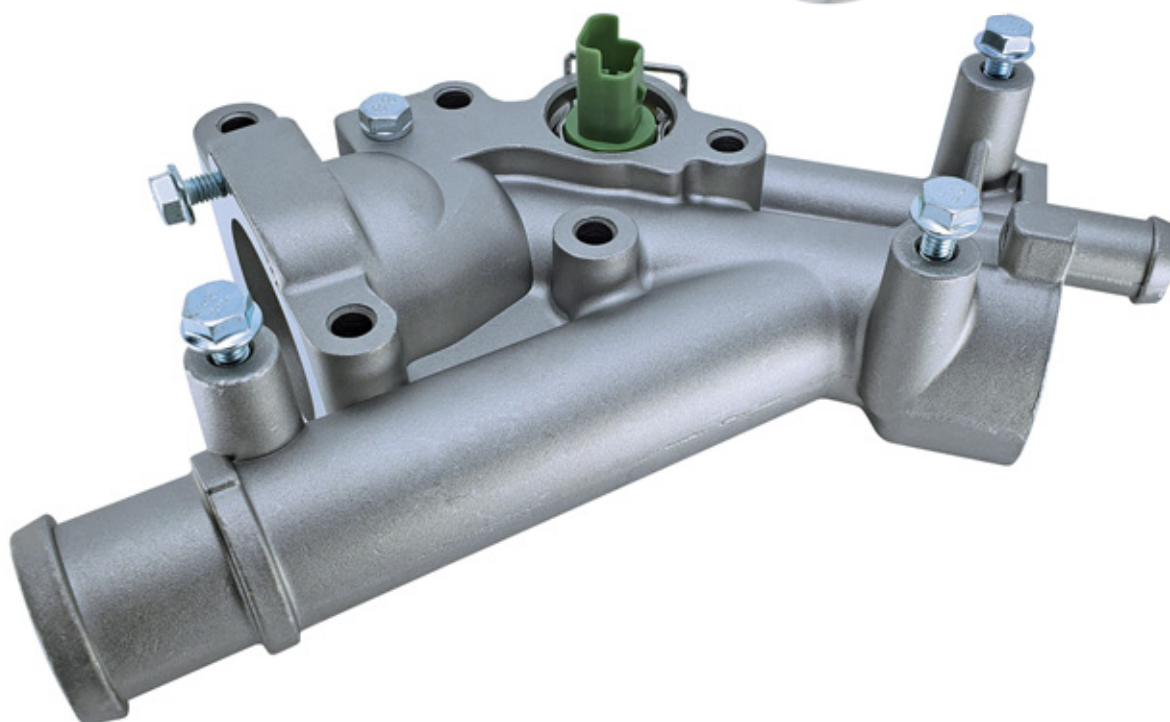





### COMBO #52

**K-20052** VT253.77+4167+4167

### HONDA

MODELO	MOTOR	COMB.	ANO
ACCORD	2.0 16V, 2.4 16V, 3.5 24V	GAS.	04/20
CITY	1.5 16V i-VTEC	FLEX	09/
CIVIC	1.8 16V i-VTEC	GAS./FLEX	06/
	2.0 16V i-VTEC	GAS./FLEX	06/
CR-V	1.5 16V, 2.0 16V, 2.4 16V	GAS./FLEX	03/20
	HR-V	1.8 16V i-VTEC	FLEX



### COMBO #53

**K-20053** VT573.89+4263

### RENAULT

MODELO	MOTOR	COMB.	ANO
KWID	1.0 12V	FLEX	17/21





### COMBO #54

**K-20054** VT574.89+4263

### RENAULT

MODELO	MOTOR	COMB.	ANO
LOGAN	1.0 12V	FLEX	17/21
SANDERO	1.0 12V	FLEX	17/21

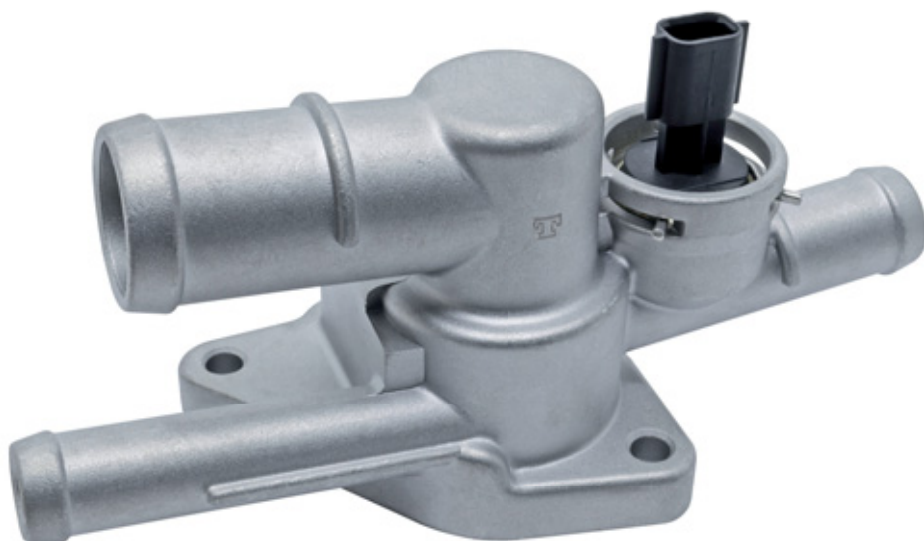

### COMBO #55

**K-20055** VT575.90+4217

### FIAT

MODELO	MOTOR	COMB.	ANO
TORO	1.8 16V E-Torq	FLEX	15/21

### JEEP

MODELO	MOTOR	COMB.	ANO
RENEGADE	1.8 16V E-Torq	FLEX	15/21



**LANÇAMENTO!**

### COMBO #56

**K-20056** VT431.82+4107

### FORD

MODELO	MOTOR	COMB.	ANO
ECOSPORT	2.0 16V DURATEC	GASOLINA	03/12
FOCUS	2.0 16V DURATEC	GASOLINA	05/08
FUSION	2.3 16V DURATEC	GASOLINA	06/09
RANGER	2.3 16V DURATEC	GASOLINA	05/12



### COMBO #57

**K-20057** VT313.92+4050

### GM-CHEVROLET

MODELO	MOTOR	COMB.	ANO
CORSA	1.0, 1.4, 1.6 8V	GASOLINA	94/98



**LANÇAMENTO!**

**LANÇAMENTO!**

### COMBO #58

**K-20058** VT211.82+4051

### GM-CHEVROLET

MODELO	MOTOR	COMB.	ANO
ASTRA	1.8 8V, 2.0 8V	GASOLINA	98/02
IPANEMA	2.0 8V	GASOLINA	97/98
KADETT	2.0 8V	GASOLINA	97/99
VECTRA	2.0 8V	GASOLINA	98/04
ZAFIRA	2.0 8V	GASOLINA	04/07



### COMBO #59

**K-20059** VT211.87+4051

### GM-CHEVROLET

MODELO	MOTOR	COMB.	ANO
ASTRA	1.8 8V, 2.0 8V	FLEX	01/04
VECTRA	2.0 8V	GASOLINA	04/11
ZAFIRA	2.0 8V	GASOLINA	04/12



**LANÇAMENTO!**



**LANÇAMENTO!**

### COMBO #60

**K-20060** VT349.87+4099

#### FIAT

MODELO	MOTOR	COMB.	ANO
FIORINO	1.3 L4 8V FIRE	GAS./FLEX	03/07
IDEA	1.4 L4 8V FIRE	FLEX	06/15
PALIO	1.0 L4 16V FIRE	GASOLINA	00/00
	1.0 L4 8V FIRE	GAS./FLEX	02/13
	1.4 L4 8V FIRE	FLEX	06/12
	1.3 L4 8V FIRE	GASOLINA	03/05
SIENA	1.0 L4 16V FIRE	GASOLINA	02/03
	1.0 L4 8V FIRE	GAS./FLEX	02/10
STRADA	1.3 L4 8V FIRE	GASOLINA	03/05
UNO	1.0 L4 8V FIRE	GAS./FLEX	02/10
	1.3 L4 8V FIRE	GAS./FLEX	04/07



### COMBO #61

**K-20061** VT349+4153

#### FIAT

MODELO	MOTOR	COMB.	ANO
DOBLÒ	1.3 L4 16V FIRE	GASOLINA	02/06
PALIO	1.0 L4 16V FIRE	GASOLINA	00/03
SIENA	1.0 L4 16V FIRE	GASOLINA	00/03



**LANÇAMENTO!**

**LANÇAMENTO!**

### COMBO #62

**K-20062** VT370.89+4110

#### CITROËN

MODELO	MOTOR	COMB.	ANO
C3	1.6 16V	GASOLINA	03/06

#### PEUGEOT

MODELO	MOTOR	COMB.	ANO
206	1.6 16V	GASOLINA	01/06
307	1.6 16V	GASOLINA	02/06



### COMBO #63

**K-20063** VT593.92+4107

#### FORD

MODELO	MOTOR	COMB.	ANO
FIESTA	1.0 12V 3cil.	GASOLINA	16/19
KA+ SEDAN	1.0 12V 3cil.	FLEX	15/21



**LANÇAMENTO!**

**LANÇAMENTO!**

### COMBO #64

**K-20064** VT579.80+4246

#### FIAT

MODELO	MOTOR	COMB.	ANO
ARGO	1.0 6V 3cil. Firefly	FLEX	17/
	1.3 8V 4cil. Firefly	FLEX	17/
CRONOS	1.3 8V 4cil. Firefly	FLEX	17/
MOBI	1.0 6V 3cil. Firefly	FLEX	17/
STRADA	1.3 8V 4cil. Firefly	FLEX	20/
UNO	1.0 6V 3cil. Firefly	FLEX	17/
	1.3 8V 4cil. Firefly	FLEX	17/



### COMBO #65

**K-20065** VT313.92+4008

#### GM-CHEVROLET

MODELO	MOTOR	COMB.	ANO
CORSA	1.4 8V ECONOFLEX	FLEX	07/09
	1.8 8V	GASOLINA	02/03
	1.8 8V FLEXPPOWER	FLEX	04/09
MERIVA	1.8 8V	GASOLINA	03/04
MONTANA	1.8 8V FLEXPPOWER	FLEX	03/10

**LANÇAMENTO!**





**LANÇAMENTO!**

### COMBO #66

**K-20066** VT313.92+4051

### GM-CHEVROLET

MODELO	MOTOR	COMB.	ANO
CORSA	1.4 8V ECONOFLEX	FLEX	10/12
MERIVA	1.4 8V ECONOFLEX	FLEX	08/12
PRISMA	1.4 8V ECONOFLEX	FLEX	09/12







### COMBO #67

**K-20067** VT487.80+4111

### CITROËN

MODELO	MOTOR	COMB.	ANO
AIR CROSS	1.6 16V	FLEX	14/12
BERLINGO	1.6 16V	GASOLINA	06/06
C3	1.6 16V	FLEX	08/12
C3 PICASSO	1.6 16V	FLEX	11/18
XSARA PICASSO	1.6 16V	FLEX	06/13

### PEUGEOT

MODELO	MOTOR	COMB.	ANO
208	1.6 16V	FLEX	14/16
307	1.6 16V	FLEX	09/12

**NOTA:** CÂMBIO AUTOMÁTICO 80°C

**LANÇAMENTO!**

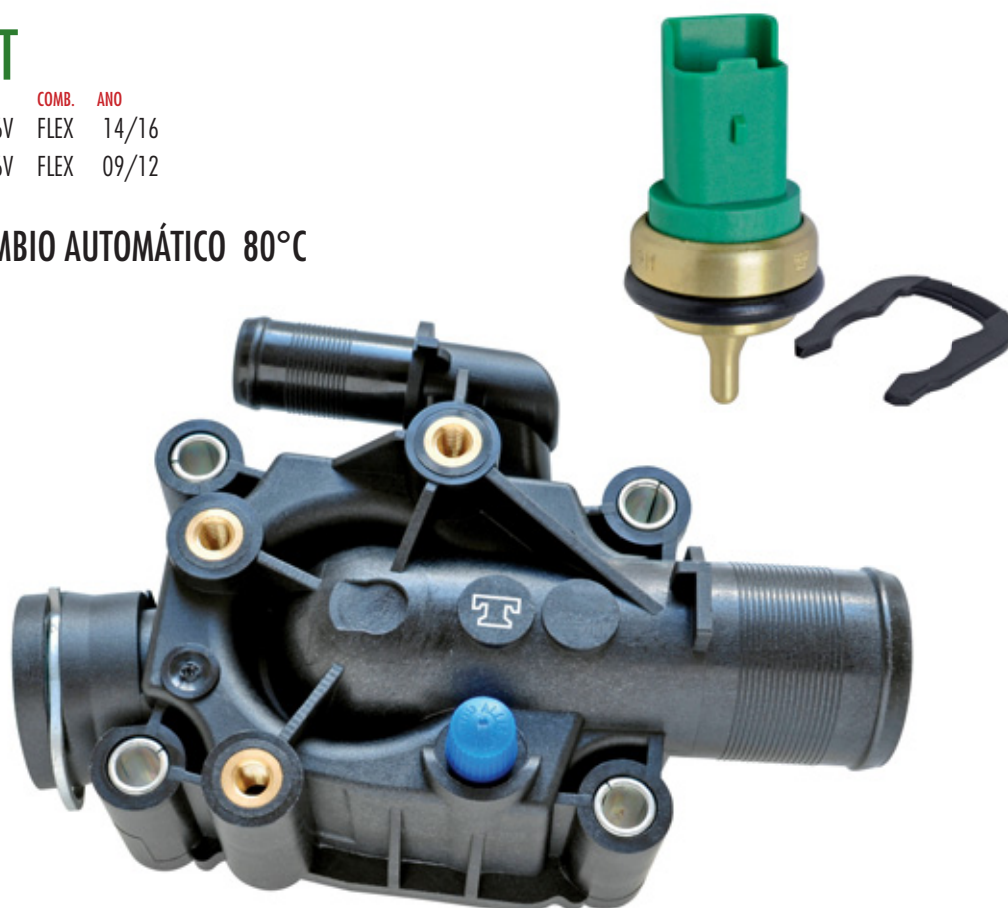



**MTE-THOMSON IND. E COM. LTDA.**  
AVENIDA MOINHO FABRINI, 1033  
CEP 09862-900  
SÃO BERNARDO DO CAMPO SP BRASIL  
PHONE: (55) (11) 4393 4343  
mte@mte-thomson.com.br  
www.mte-thomson.com.br

Cooling and  
Engine Management  
Competence

**MTE-THOMSON INC. - USA DIVISION**  
35 SW 12TH AVE - BLDG #35 SUITE 112  
DANIA BEACH - FL 33004  
PHONE: (1) (954) 564-5955  
noto@mte-thomson.com.br  
www.mte-thomson.com

**MTE-THOMSON EUROPE**  
ARSTERDAMM, 82  
28277 - BREMEN - GERMANY  
PHONE: (49) (0) 421 875027  
stevan.manzan@mte-thomson.com.br  
www.mte-thomson.de

**CatE-MTE**  
CATÁLOGO ELETRÔNICO  
WEB CATALOG

CERTIFIED  
**TecDoc®**  
DATA SUPPLIER



[www.mte-thomson.com.br](http://www.mte-thomson.com.br)

